



Thru-beam sensor (pair)

OBE10M-18GM60-SE5-V1-1C



- Strong metallic housing in cylindrical shape M18 x 1
- Not sensitive to ambient light
- Degree of protection IP67
- Very high detection range

Thru-beam sensor (pair)



Function

The optical sensors of this series have an M18 threaded housing that is optionally available in plastic or metal. The sensors are robust and versatile. Focusing on the essential requirements simplifies selection and commissioning, saving time and costs.

Dimensions

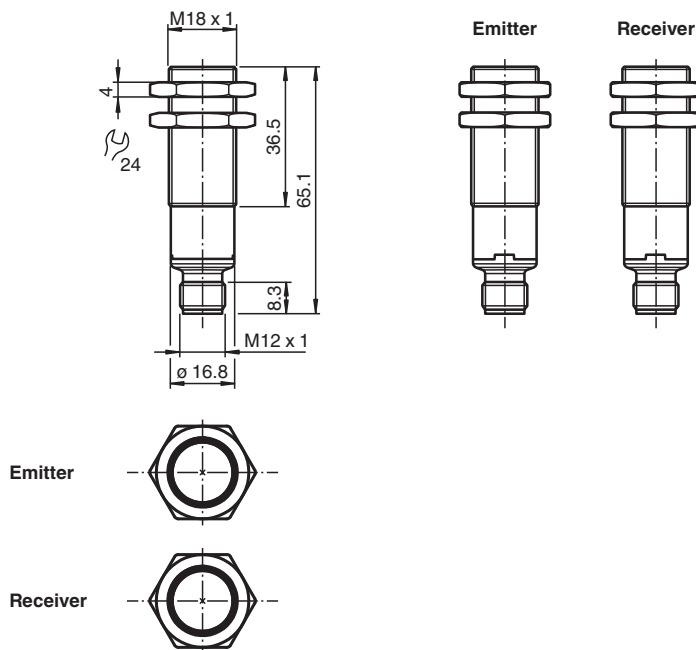

Technical Data

System components

Emitter	OBE10M-18GM60-S-V1-1C
Receiver	OBE10M-18GM60-E5-V1-1C

General specifications

Effective detection range	0 ... 10 m
---------------------------	------------

Release date: 2021-12-16 Date of issue: 2021-12-16 Filename: 70134683_eng.pdf

Refer to "General Notes Relating to Pepperl+Fuchs Product Information".

Pepperl+Fuchs Group
www.pepperl-fuchs.com

USA: +1 330 486 0001
fa-info@us.pepperl-fuchs.com

Germany: +49 621 776 1111
fa-info@de.pepperl-fuchs.com

Singapore: +65 6779 9091
fa-info@sg.pepperl-fuchs.com

pf PEPPERL+FUCHS

Technical Data

Threshold detection range		17 m
Light source		LED
Light type		modulated visible red light
Diameter of the light spot		approx. 110 mm at 1 m
Angle of divergence		approx. 2.9 °
Optical face		frontal
Ambient light limit		EN 60947-5-2 10000 Lux
Functional safety related parameters		
MTTF _d		564 a
Mission Time (T _M)		20 a
Diagnostic Coverage (DC)		0 %
Indicators/operating means		
Operation indicator		LED green: on - power on flashing (4 Hz) - short circuit
Function indicator		Receiver: yellow LED permanently lit - output active permanently off - output inactive flashing (4 Hz) - insufficient operating reserve
Control elements		light/dark on electrically switchable
Electrical specifications		
Operating voltage	U _B	10 ... 30 V DC
Ripple		max. 10 %
No-load supply current	I ₀	< 25 mA
Protection class		III
Output		
Switching type		The switching type of the sensor is adjustable. The default setting is: Q - Pin4: PNP output / light-on L/D-On - Pin2: Low-active input
Signal output		1 PNP output, short-circuit protected, reverse polarity protected, open collector
Switching voltage		max. 30 V DC
Switching current		max. 100 mA , resistive load
Voltage drop	U _d	≤ 2 V DC
Switching frequency	f	500 Hz
Response time		≤ 1 ms
Conformity		
Product standard		EN 60947-5-2
Approvals and certificates		
UL approval		E87056 , cULus Listed , class 2 power supply , type rating 1
Ambient conditions		
Ambient temperature		-40 ... 60 °C (-40 ... 140 °F)
Storage temperature		-40 ... 70 °C (-40 ... 158 °F)
Mechanical specifications		
Degree of protection		IP67
Connection		4-pin, M12 x 1 connector
Material		
Housing		brass, nickel-plated
Optical face		PMMA
Connector		Plastic
Mass		approx. 23 g per device

Connection

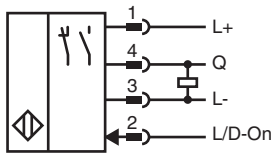

Connection

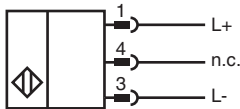

Connection Assignment

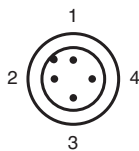

Wire colors in accordance with EN 60947-5-2

- 1 | BN (brown)
- 2 | WH (white)
- 3 | BU (blue)
- 4 | BK (black)

Indication

Emitter

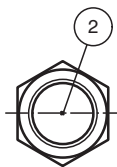
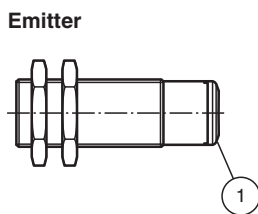

1	Operating display	green
2	Emitter	

Receiver

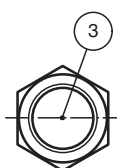
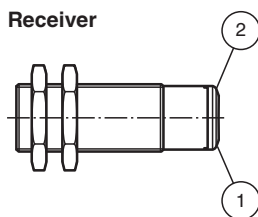



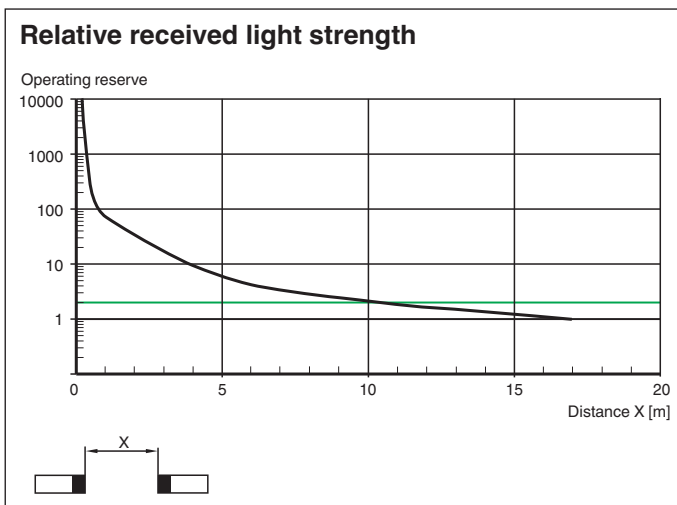
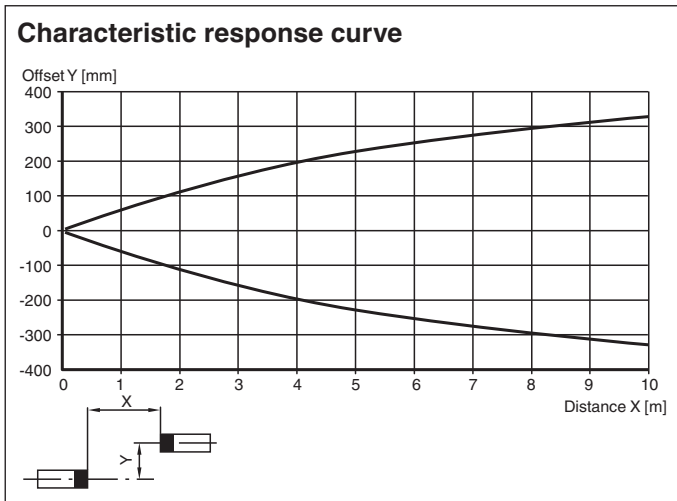

1	Operating display	green
2	Signal display	yellow
3	Receiver	

Release date: 2021-12-16 Date of issue: 2021-12-16 Filename: 70134683_eng.pdf

Characteristic Curve



Accessories

	BF 18	Mounting flange, 18 mm
	CPZ18B03	Mounting Bracket with swivel nut
	BF 18-F	Plastic mounting adapter, 18 mm
	BF 5-30	Universal mounting bracket for cylindrical sensors with a diameter of 5 ... 30 mm

Release date: 2021-12-16 Date of issue: 2021-12-16 Filename: 70134683_eng.pdf